

# Xpelair Wiring Diagrams

## Xpelair XIL Inline shower fan systems

XIL100/125/150/XXS100

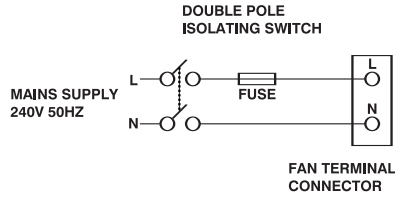

XIL100T/125T/150T/XXS100T

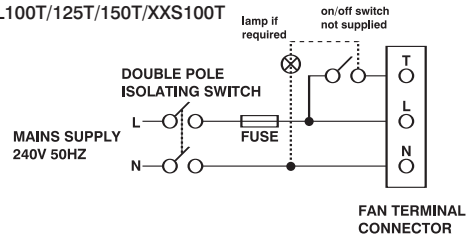

## Xpelair BriteX LoVolt & BriteX Turbo

BX100W/C/BX100+W/C

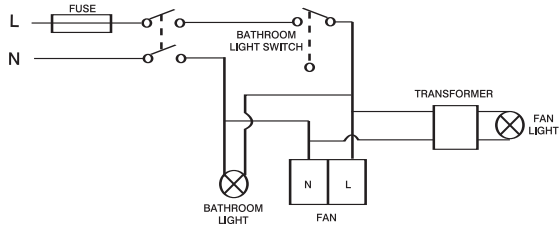

BX100WT/CT/BX100+WT/CT

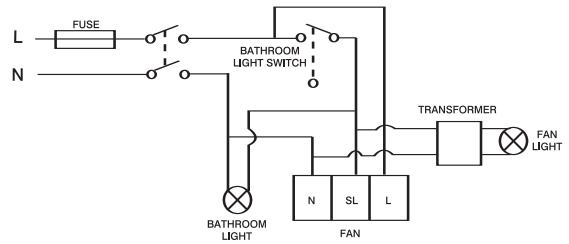

## Xpelair XIM

XIM100

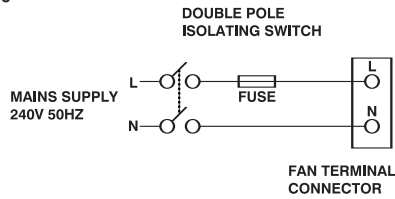

XIM100T

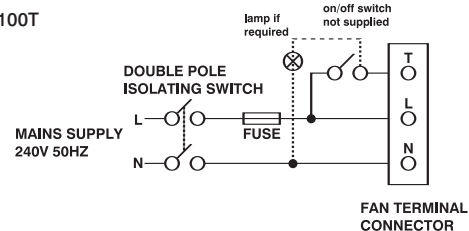

XIM150/200/100+/125

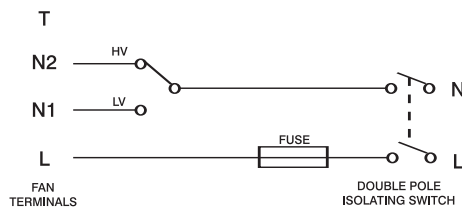

XIM150T/XIM150+T

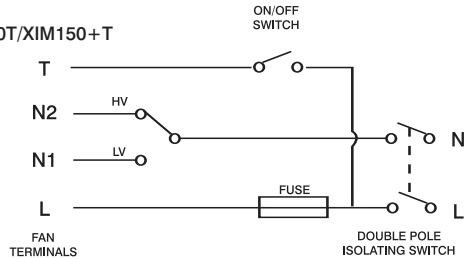

## Xpelair Slimline 150

Slimline SL150

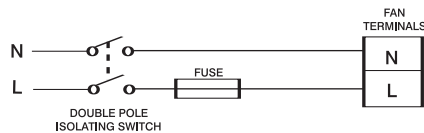

Slimline SL150P

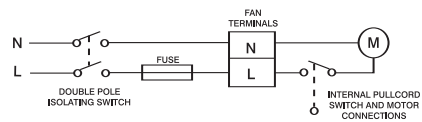

Slimline SL150HT

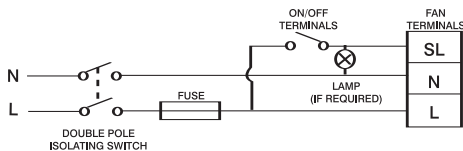

### Xpelair GX6, GXC6 & GXC9

GX6

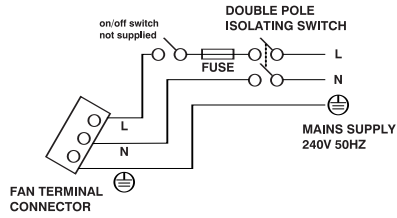

GXC6, GXC6T, GXC6SC & GXC9

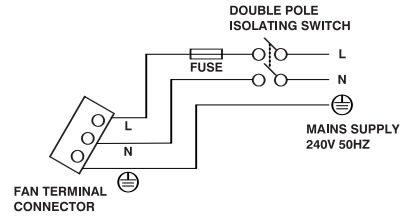

### Xpelair Premier DX400 & CF40

DX400

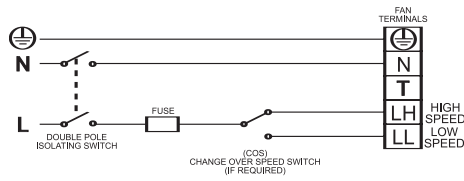

DX400PC

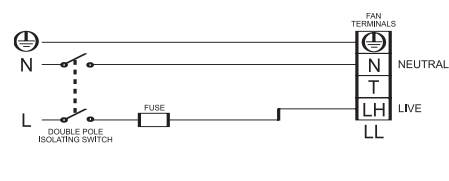

DX400T/CF40/CF40TD

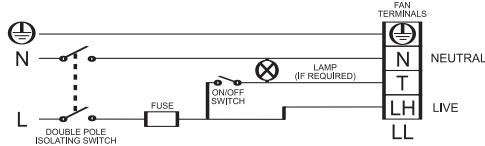

DX400RS/CF40RSTD

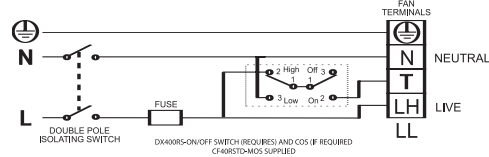

### Xpelair Nouvelle Cuisine

Kitchen Canopies

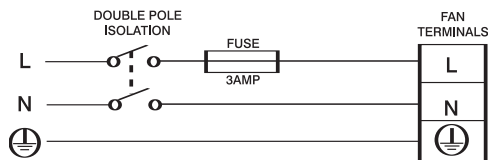

### Xpelair CX10 & CMF

CX10/CMF

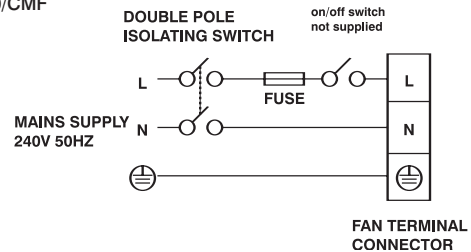

### Xpelair Xplus

Xplus275/340

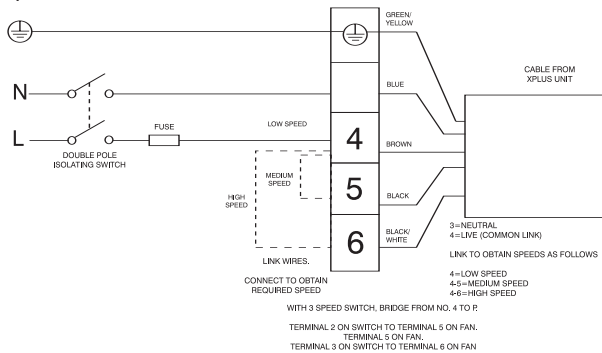

Xplus275/340 with 3 speed switch

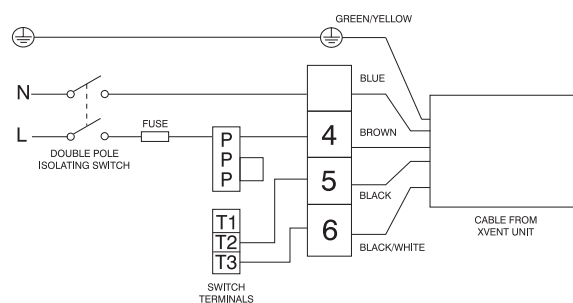

# Xpelair Wiring Diagrams

## Xpelair Xplus 250 & 400 DC 8CV

Xplus250/400

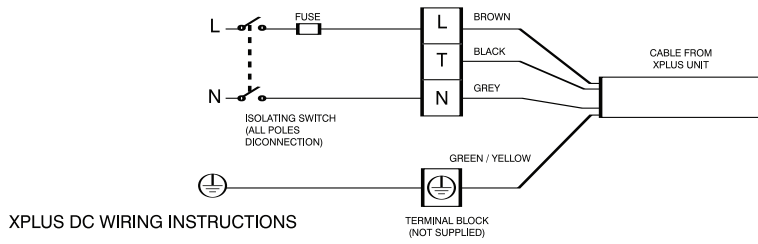

Xplus250/400 with 3 speed switch

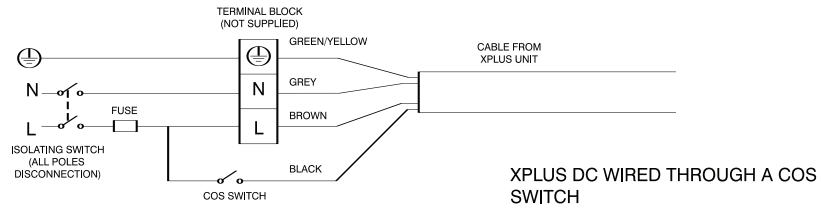

## Xpelair Xcell 150 Longlife

Xcell 150

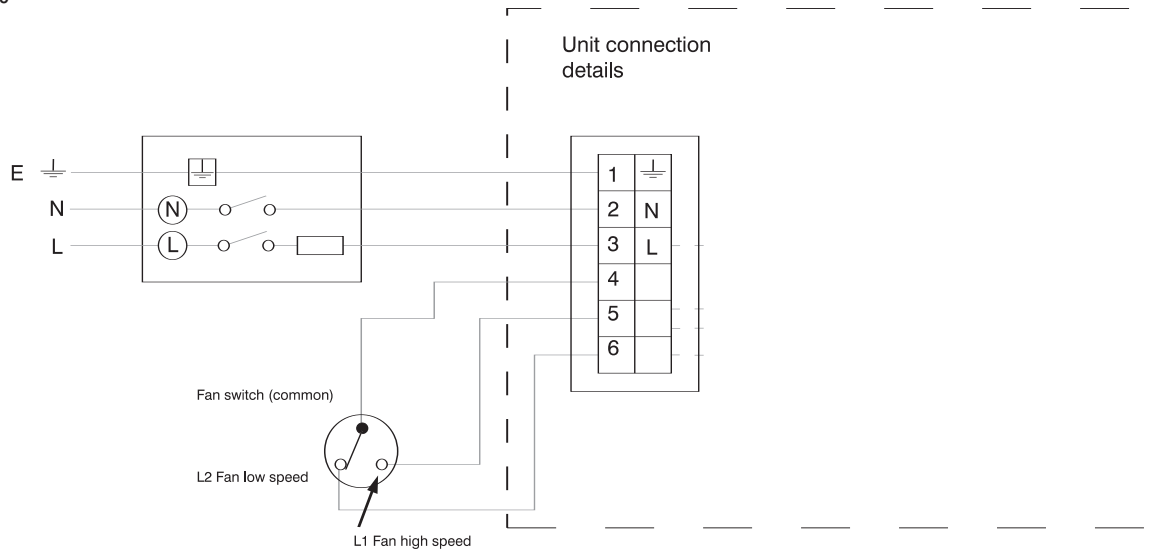

## Xpelair Xcell 200 Longlife

Xcell 200

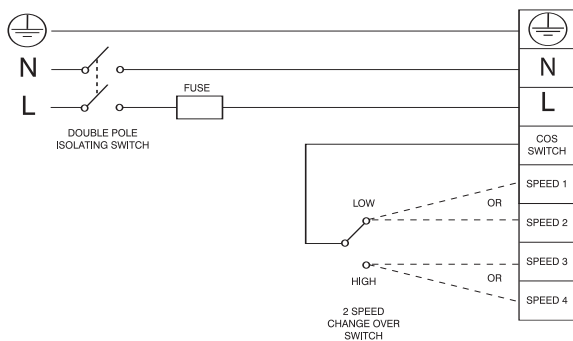

Xcell 200BP

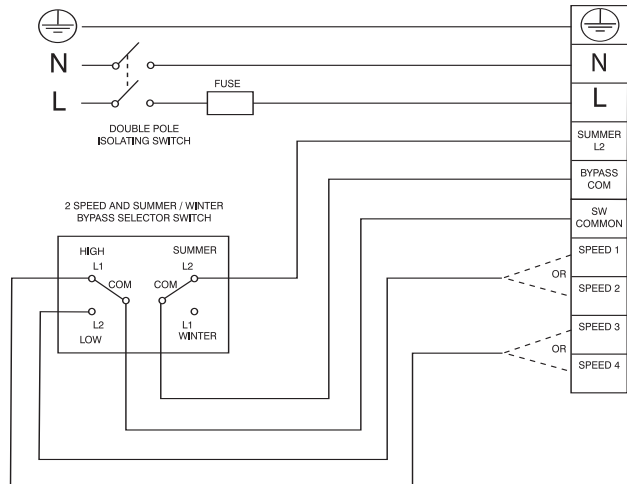

### Xpelair Xcell 270 Longlife

Xcell 270

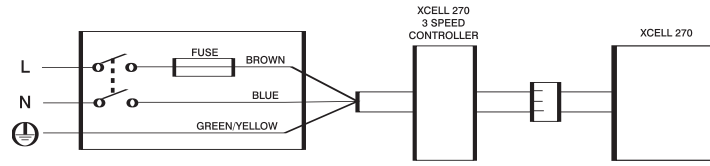

### Xpelair Xcell 300 & 400 Longlife

Xcell 300/400

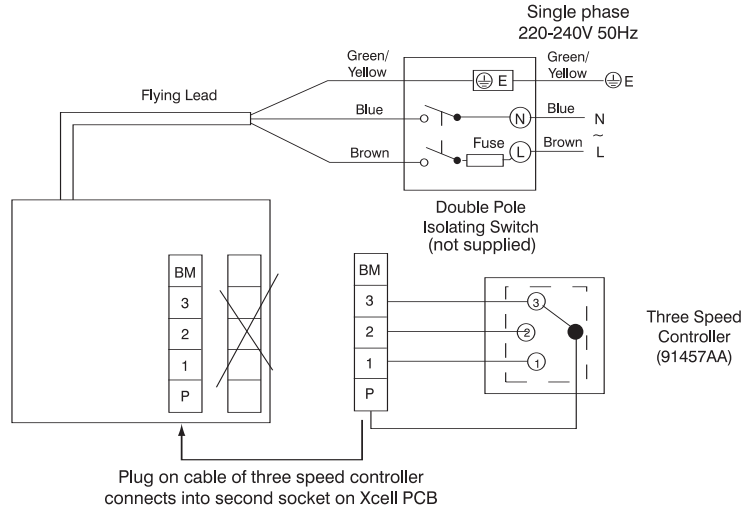

### Xpelair Xcell 600 Longlife

Xcell 600

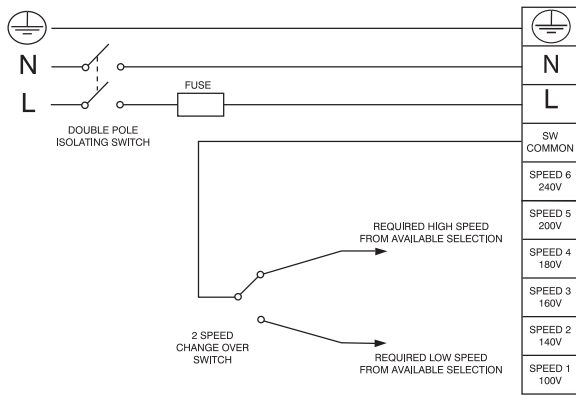

Xcell 600BP

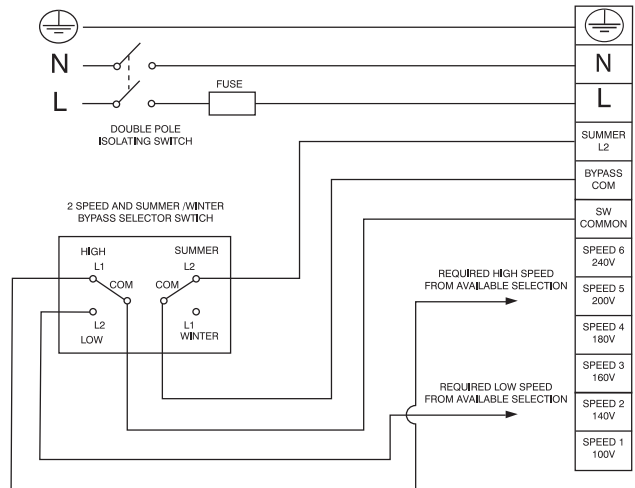

### Xpelair EverDri LongLife

EverDri XEDW/XEDL

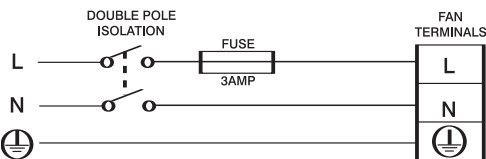

### Xpelair LoVolt XHR150

XHR 150

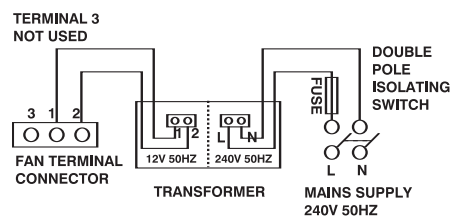

# Xpelair Wiring Diagrams

## Xpelair GX6, GX9 & GX12

GX6

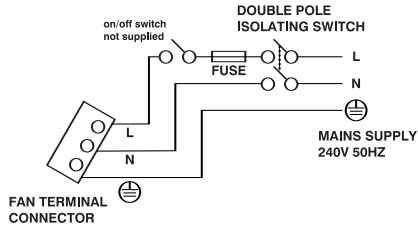

GX9/GX12

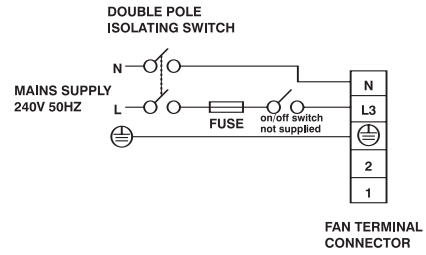

## Xpelair PX6, PX9 & PX12

PX6

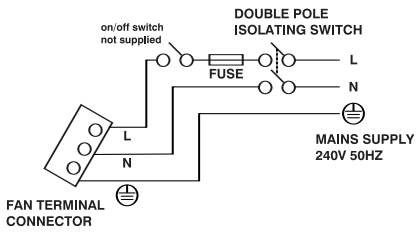

PX9/PX12

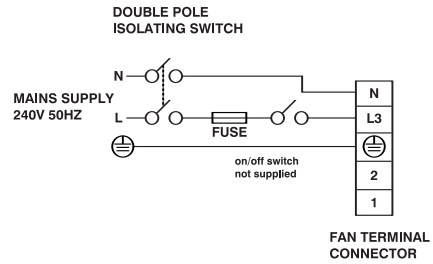

## Xpelair RX6, RX9 & RX12

RX6

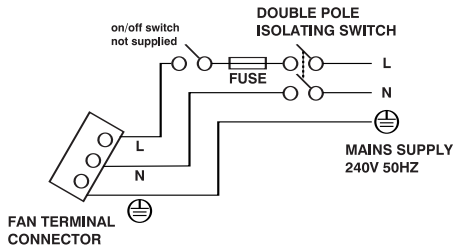

RX9/RX12

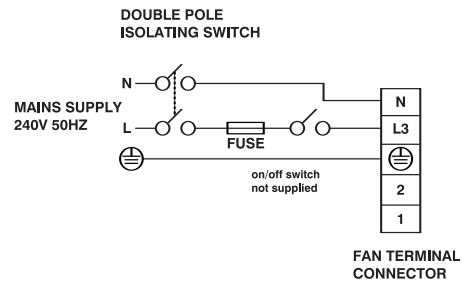

## Xpelair WX6, WX9 & WX12

WX6

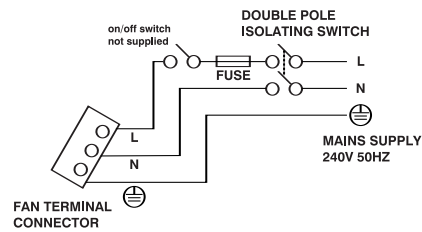

WX6T

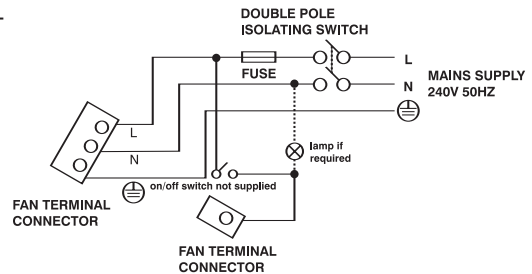

WX9/WX12

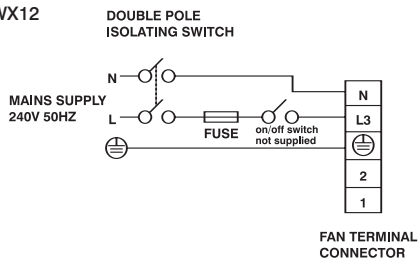

## Xpelair ChefX

ChefX Tempo/Presto/Mezzo

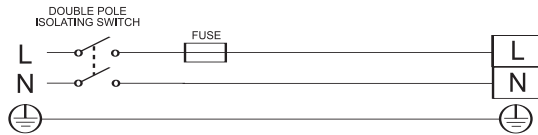

## Xpelair WH30 & WHP30

WH30

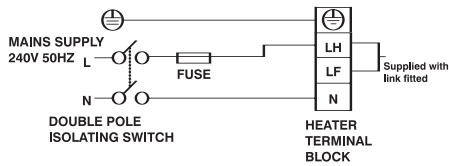

WH30 with HC301

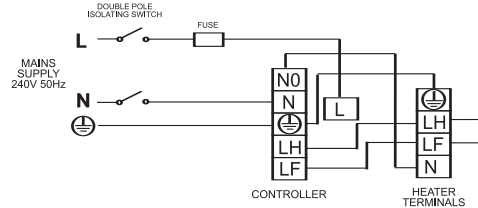

WHP30 with HC301

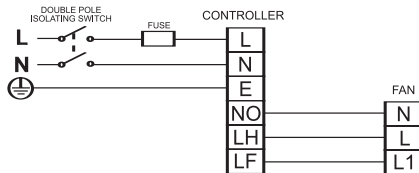

## Xpelair WH60

WH60-single phase

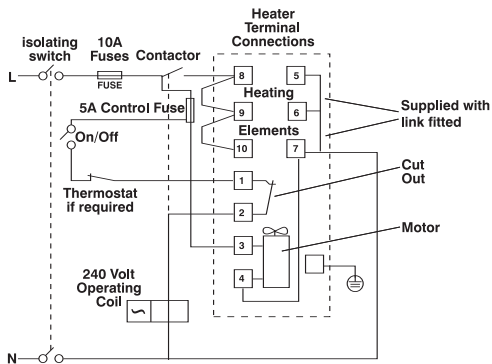

WH60-3 phase using a 240V contactor coil

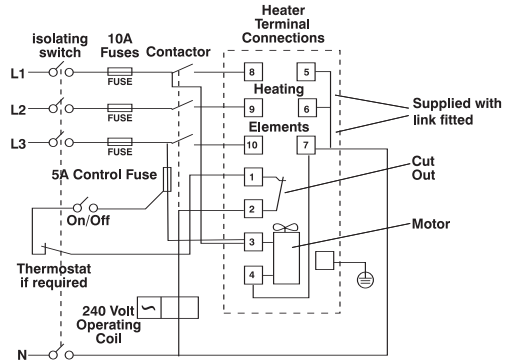

WH60-3 phase using a 415V contactor coil

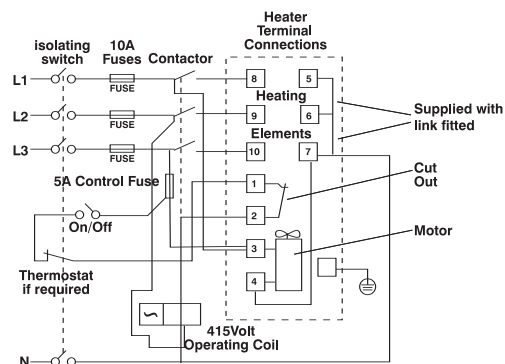

# Xpelair Wiring Diagrams

## Xpelair ScreenHeat & PlinthHeat

PlinthHeat with integral controls

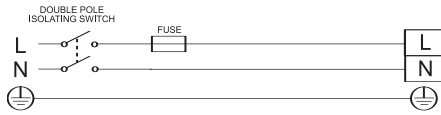

PlinthHeat with remote control

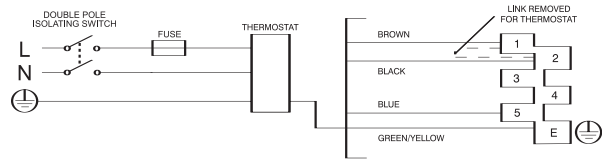

## Xpelair Whisper

NWAN

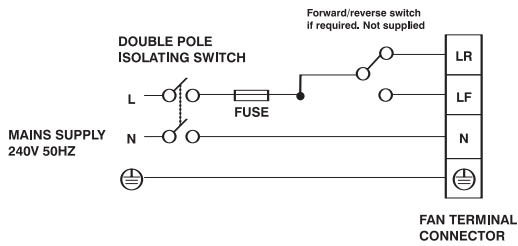

## Xpelair XPMS, XPMa & XRA

315/350/400

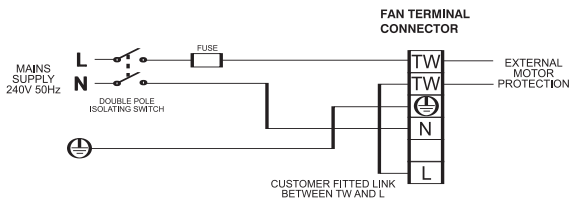

450

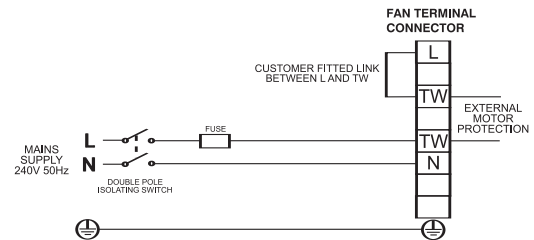

500/630

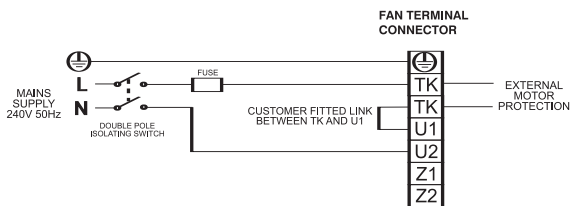

315/350/400 with XCW controller

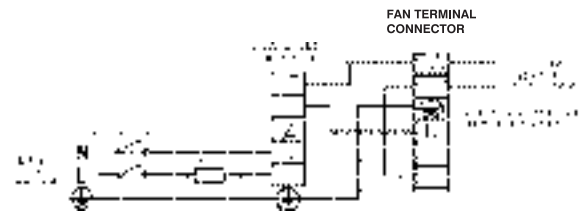

450 with XCW controller

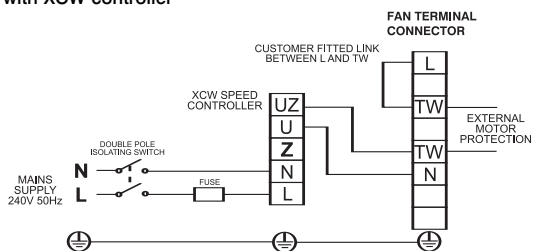

500/630 with XCW controller

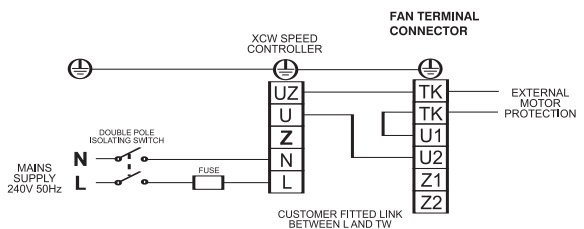

### Xpelair XSCS & XSCA

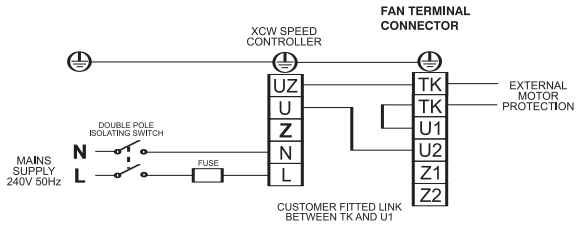

### Xpelair XMV

Single phase

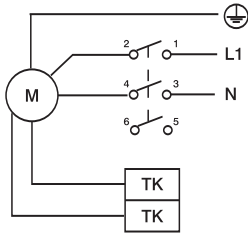

3 phase

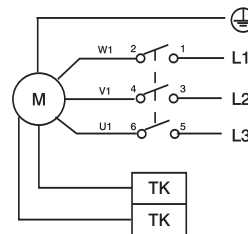

### Xpelair XID & XIDP

XID/XIDP

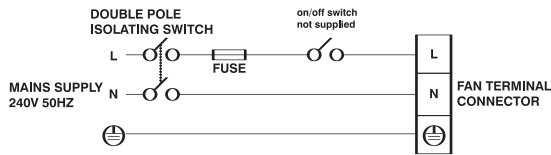

XID/XIDP with XIC1 speed controller

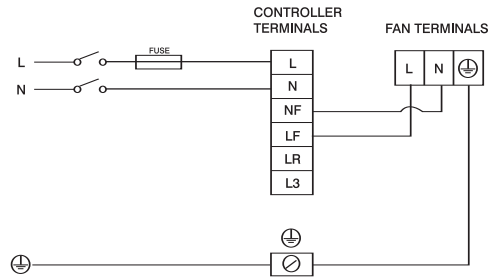

### Xpelair LoSound XSFA

XSFA

